



M30

CONT 28 kVA



THREE-PHASE SYNCHRONOUS GENERATOR

Datasheet for 4 poles -50Hz @ 1500rpm/ 60Hz @ 1800rpm

Ambient Temperature	40 °C	Method of Cooling	Air cooling
Temperature Rise	125 °C	Direction of Rotation	Clockwise
Insulation Class	H	Maximum Over-speed	2250r/min
Power Factor	0.8	Degree of Protection / Enclosure	IP23
Excitation	Brushless	Altitude	1000m
Winding Pitch	2/3	Stator winding	DLL
Pole	4	Number of Terminal	12
Duty	S1- Continuous	Rotor	With damping cage
Waveform	TIF<50		THF<2%
Waveform distortion	BS EN 61000-6-2&BS EN 61000-6-4,VDE 0875G,VDE0874N		
Radio interference	Noload<1.5%,Non-distorting balanced linear load<5%		
AVR MODEL AVR	Standard	Selection	
	SX460	AS440	KRS440
Voltage Regulation - in steady state condition	±1.0	±1.0	±1.0
Short Circuit Current Capacity	Control does not sustain a short circuit current		

Electrical Characteristic

Frequency	Hz	50				60			
Voltage (series star) Y	V	380/220	400/231	415/240	440/254	416/240	440/254	460/266	480/277
Voltage (parallel star) YY	V	190/110	200/115	208/120	220/127	208/120	220/127	230/133	240/138
Voltage (series delta) Δ	V	220	230	240	254	240	254	266	277
Rated power at Class H (125 °C) temperature rise	kVA	27.5	27.5	27.5	22.5	32.5	34.4	34.4	35
	kW	22.0	22.0	22.0	18.0	26.0	27.5	27.5	28.0
Efficiency at Class H (P.F.=0.8)	4/4%	85.3	85.8	86	86.3	85.3	85.5	86	86
	3/4%	87.3	87.4	87.5	87.7	87.2	87.3	87.6	87.7
	2/4%	87.9	87.9	87.8	87.4	87.8	87.9	87.9	87.8
Efficiency at Class H (P.F.=1.0)	4/4%	88.4	88.8	89	89.3	88.3	88.5	88.9	89
	3/4%	90	90.2	90.2	90.4	90	90	90.1	90.2
	2/4%	90.6	90.5	90.4	90.2	90.3	90.4	90.3	90.2

Reactances (%) at Class H

Direct axis synchronous reactance unsaturated	Xd	1.828	1.65	1.533	1.667	2.163	2.047	1.872	1.75
Direct axis transient reactance saturated	X'd	0.188	0.17	0.158	0.172	0.21	0.199	0.182	0.17
Direct axis subtransient reactance saturated	X''d	0.122	0.11	0.102	0.111	0.148	0.14	0.128	0.12
Quadrature axis synchronous reactance unsaturated	Xq	0.92	0.83	0.771	0.838	1.088	1.029	0.942	0.88
Quadrature axis subtransient reactance saturated	X''q	0.211	0.191	0.177	0.192	0.247	0.234	0.214	0.2
Leakage reactance	X1	0.073	0.066	0.061	0.066	0.087	0.082	0.075	0.07
Negative sequence reactance saturated	X2	0.166	0.15	0.139	0.152	0.198	0.187	0.171	0.16
Zero sequence reactance unsaturated	X0	0.08	0.072	0.067	0.073	0.094	0.089	0.081	0.076
Short-circuit ratio	Kcc	0.5470	0.6061	0.6523	0.5999	0.4623	0.4885	0.5342	0.5714

Short-circuit transient time constant (sec.)	T'd	0.022							
Subtransient time constant (sec.)	T''d	0.0055							
Open circuit time constant (sec.)	T'do	0.45							
Armature time constant (sec.)	Ta	0.0065							
Stator Winding Resistance (20°C)	ohm	0.25							
Rotor Winding Resistance (20°C)	ohm	0.74							
Exciter Stator Resistance (20°C)	ohm	22							
Exciter Rotor Phase resistance	ohm	0.12							
No load excitation current	io (A)	0.6	0.62	0.64	0.62	0.55	0.57	0.63	0.65
Full load excitation current	ic(A)	1.95	2	2	1.95	1.9	1.95	2	2
Cooling air requirement	m ³ /sec	0.095m ³ /s 200cfm				0.119m ³ /s 250cfm			

Mechanical Characteristic

Configuration	Single Bearing	Double Bearing
Type of Construction	B2-SAE	IM B34
Total Weight - kgs	151	155
Weight wound stator - kgs	55	55
Weight wound rotor - kgs	49.74	50.52
Inertia (J) [kgm ²]	0.1909kgm ²	0.1909kgm ³
Drive end bearing / Lubrication		BALL.6309-2RS(ISO)
Non-drive end bearing / Lubrication	BALL.6306-2RS(ISO)	BALL.6306-3RS(ISO)
Packing crate size (cm)	63X49X58	70X49X57

Winding 311 / 0.8 Power Factor

RATINGS

Class - Temp Rise		Cont. F - 105/40°C				Cont. H - 125/40°C				Standby - 150/40°C				Standby - 163/27°C			
50 Hz	Series Star (V)	380	400	415	440	380	400	415	440	380	400	415	440	380	400	415	440
	Parallel Star (V)	190	200	208	220	190	200	208	220	190	200	208	220	190	200	208	220
	Series Delta (V)	220	230	240	254	220	230	240	254	220	230	240	254	220	230	240	254
	kVA	25.0	25.0	25.0	20.5	27.5	27.5	27.5	22.5	N/A				N/A			
kW	20.0	20.0	20.0	16.4	22.0	22.0	22.0	18.0									
Efficiency (%)	86.1	86.5	86.7	86.9	85.3	85.8	86.0	86.4									
kW Input	23.2	23.1	23.1	23.0	25.8	25.6	25.6	25.5									

60 Hz	Series Star (V)	416	440	460	480	416	440	460	480	416	440	460	480	416	440	460	480
	Parallel Star (V)	208	220	230	240	208	220	230	240	208	220	230	240	208	220	230	240
	Series Delta (V)	240	254	266	277	240	254	266	277	240	254	266	277	240	254	266	277
	kVA	30.0	31.3	31.3	32.5	32.5	34.4	34.4	35.0	N/A				N/A			
kW	24.0	25.0	25.0	26.0	26.0	27.5	27.5	28.0									
Efficiency (%)	86.1	86.3	86.6	86.7	85.4	85.5	85.9	86.1									
kW Input	27.9	29.0	28.9	30.0	30.4	32.2	32.0	32.5									

DIMENSIONS

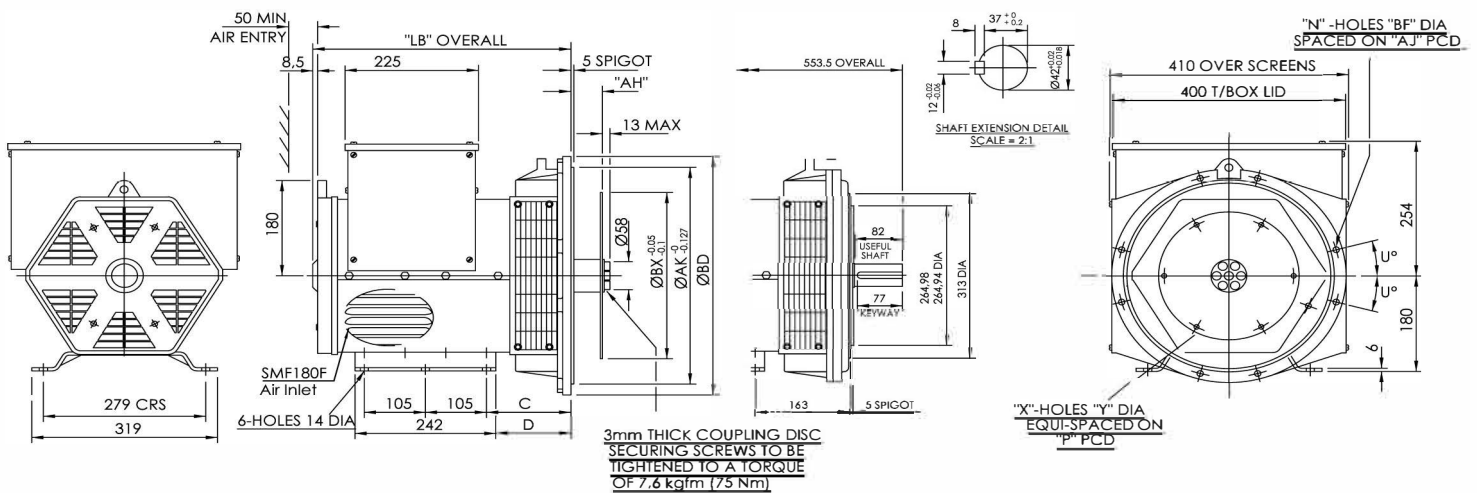

DIMENSIONS(mm)			WEIGHE	
SAE	TYPE	LB	KG	
SAE 2	QYI 184F	560.5	147	
SAE 3	QYI 184F	533	148	
SAE 4/5	QYI 184F	521	147	

COUPLING DISC					
SAE	BX	P	X	Y	AH
11.5	352.42	333.38	8	11	39.6
10	314.32	295.28	8	11	53.8
8	263.52	244.48	6	11	62
7.5	241.3	222.25	8	9	30.2
6.5	215.9	200.02	6	9	30.2

FLANGE(mm)								
	BD	AK	AJ	U°	BF	n	C	D
SAE5	356	314.32	333.38	22.5	11	8	133	117
SAE4	402	361.95	381	15	11	8	133	117
SAE3	451	409.58	428.62	15	11	8	145	129
SAE2	489	447.68	466.72	15	11	12	172	156

COUPLING DISC				FLANGE	
VER	MOD	DRW	Date		
Design	APP		2018.01		mm
CHK					

**50
Hz**

Winding 311

THREE PHASE EFFICIENCY CURVES

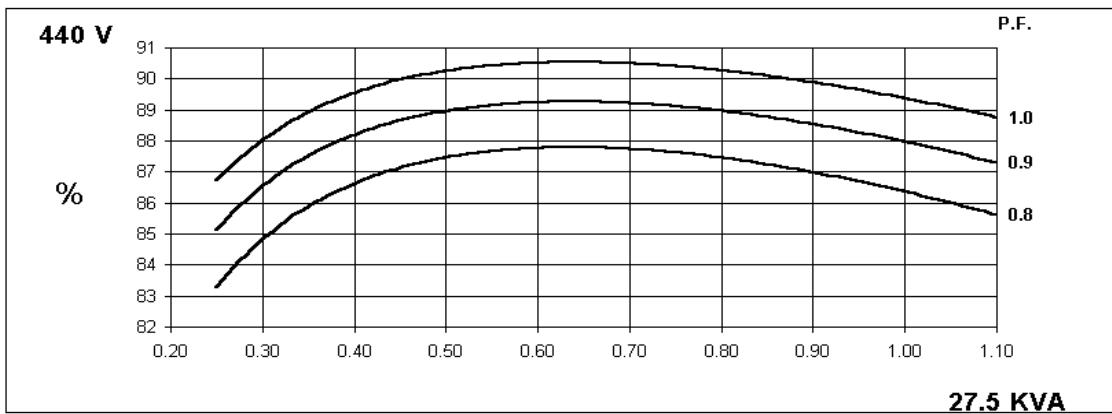
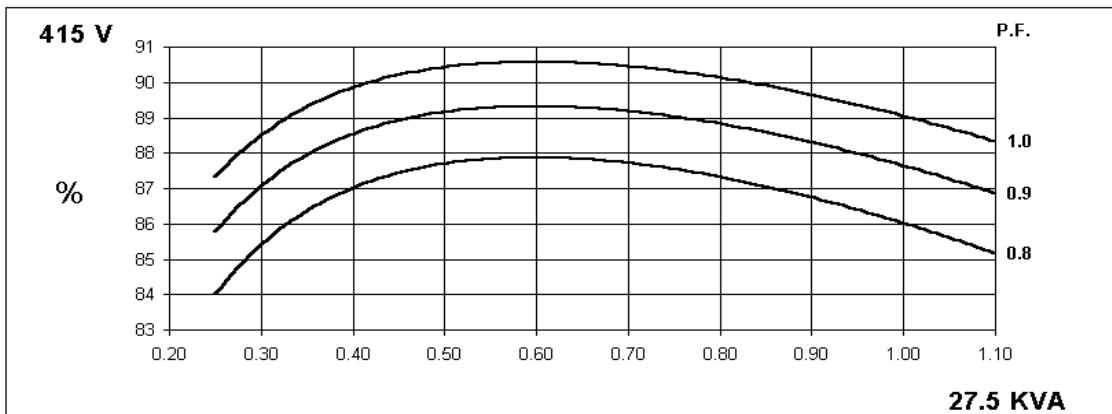
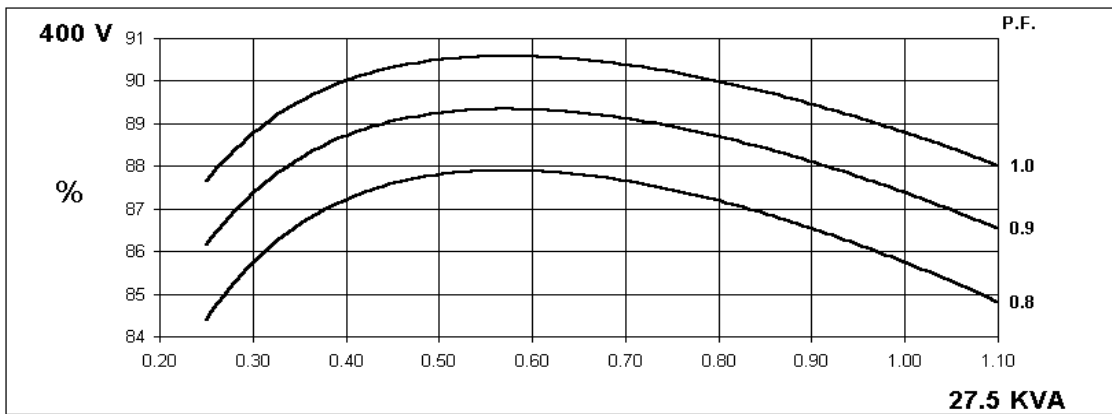
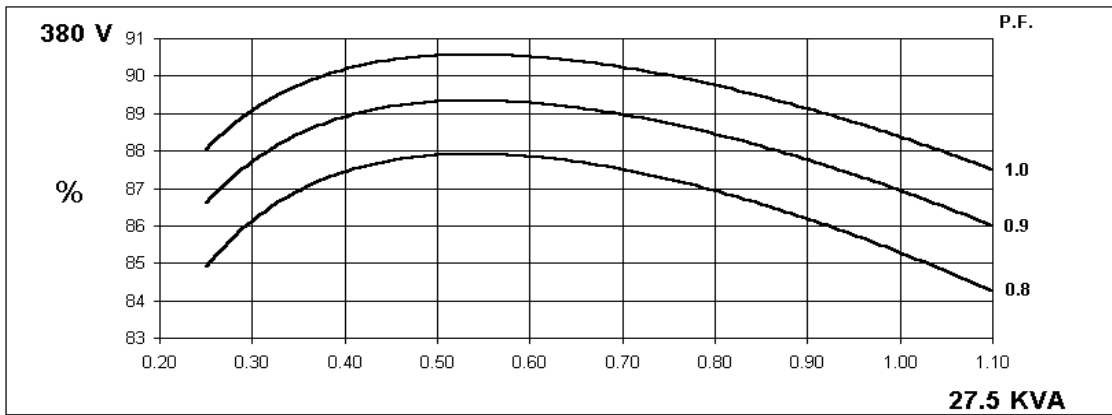

Winding 311

THREE PHASE EFFICIENCY CURVES

**60
Hz**

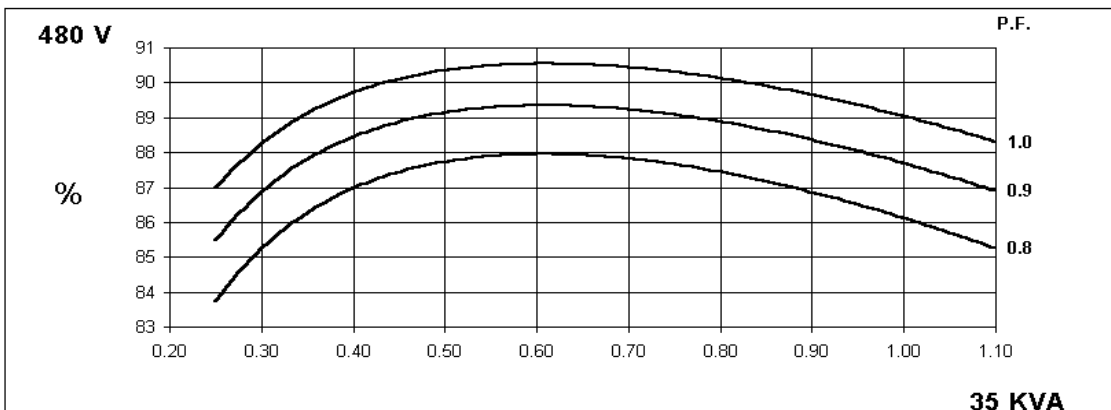
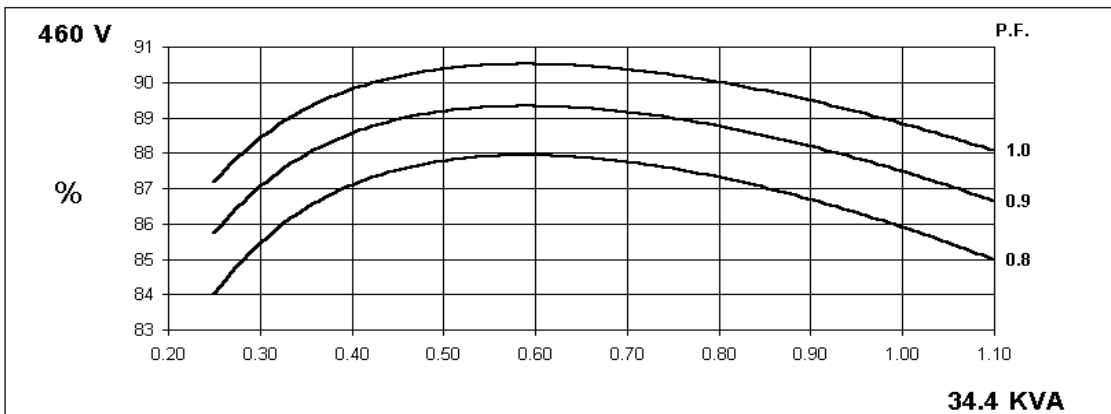
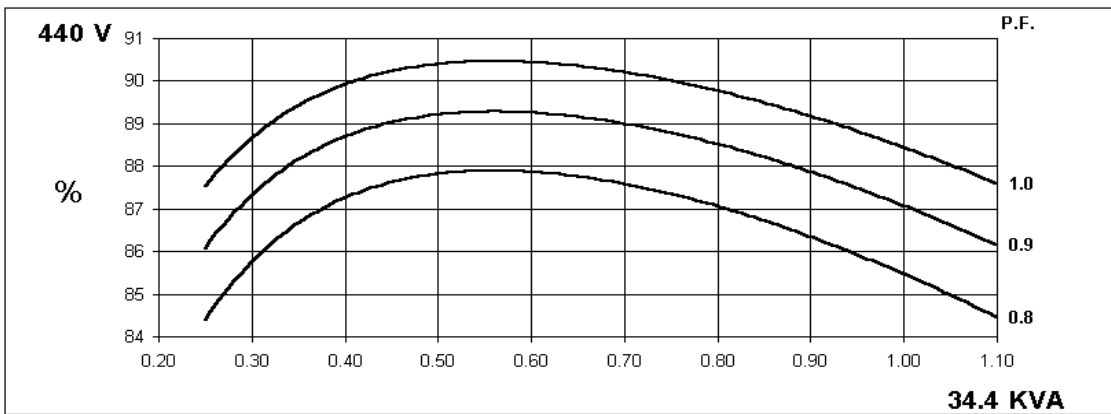
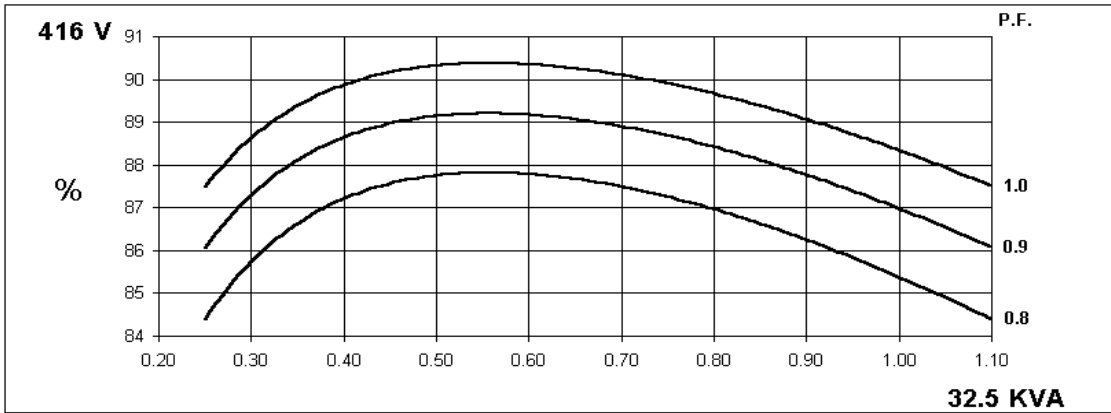

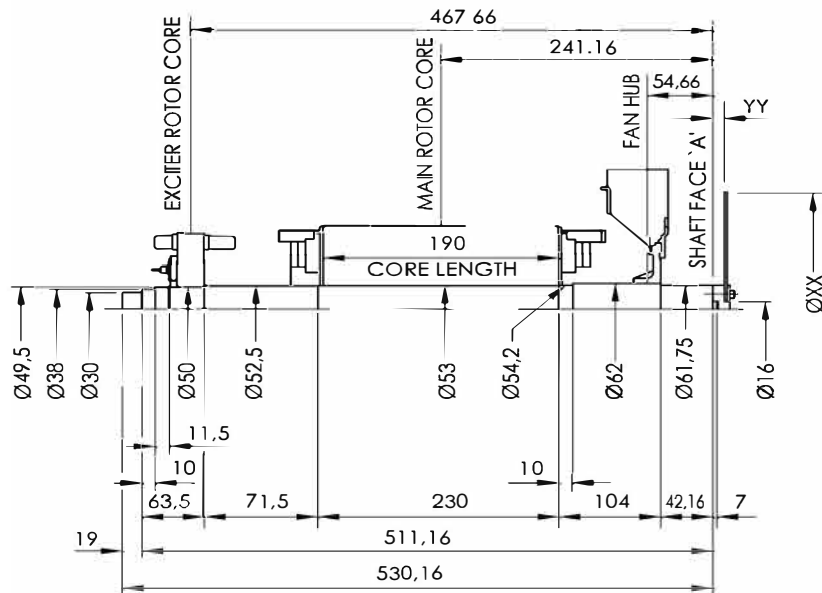

COMPONENT	Wt kg	J kgm ²
EX. ROTOR	6,530	0,0253
MAIN ROTOR	32,850	0,1558
FAN	0,744	0,0061
SHAFT	9,614	0,0037
TOTAL	49,738	0,1909

ADAPTOR SAE No.	COUPLING SAE No.	COUPLING DIMENSIONS		COUPLING ASSEMBLY WEIGHT kg	COUPLING DISC J kgm ²
		XX	YY		
6	7½	241,2	31,7	1,810	0,0078
4/5	7½	241,2	0	1,071	0,0078
4/5	8	263	31,7	2,018	0,0111
4	10	314	23,8	2,377	0,0225
3	10	314	35,8	2,657	0,0225
3	1½	352	21,5	2,793	0,0356

VER	MOD	DRW	Date	1:1
Design		APP		⊕
CHK		Date	2018.01	mm

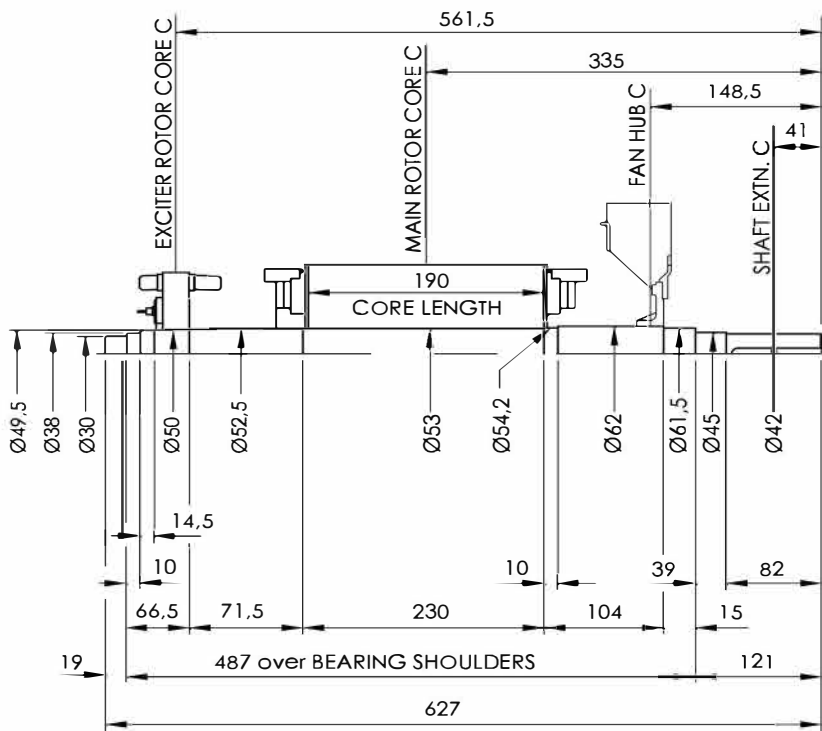

COMPONENT	Wt kg	J kgm ²
EX. ROTOR	6,530	0,0253
MAIN ROTOR	32,850	0,1558
FAN	0,744	0,0061
SHAFT	10,397	0,0037
TOTAL	50,521	0,1909

VER	MOD	DRW	Date	1:1
Design		APP		⊕
CHK		Date	2018.01	mm

